

N35L-U-A

High Power LED

Introduction

The N35L-U-A LED from SemiLEDs brings industry leading technology to the UV lighting market with its high quality and performance. With a ceramic substrate, N35L-U-A LEDs from SemiLEDs feature very high brightness and efficacy, as well as excellent lifetime.

Table of Contents

Characteristics	1
Relative Spectral Power Distribution	4
Typical Spatial Radiation Pattern	4
Thermal Design	5
Typical Forward L-I Characteristics	6
Typical Forward I-V Characteristics	6
Typical Forward L-T _j Characteristics	7
Mechanical Dimensions	8
Recommended Solder Pad Design	9
Packing Information	10
Recommended Soldering Profile	11

RoHS Compliant

Characteristics

Absolute Maximum Ratings (Tj=25°C)

Parameter	Rating
	UV Series
DC Forward Current (mA)	1,000 mA
LED Junction Temperature	150°C
LED Operating Temperature	-40°C~125°C
Storage Temperature	-40°C~125°C
Soldering Temperature	Max. 260°C / Max. 10sec. (JEDEC 020c)
ESD Sensitivity	2,000 V HBM (JESD-22A-114-B)
Preconditioning	Acc. to JEDEC Level 2

General Characteristics at 350mA (Tj=25°C)

Part number	Color	Peak Wavelength λ_p		$2\theta_{1/2}$	Temperature Coefficient of Vf (mV/°C)	Thermal Resistance Junction to Pad
		Min	Max		$\Delta V_f / \Delta T_j$	(°C/W) $R\theta_{J-L}$
N35L-U-A	U40	380	390	125	-2~-4	4.4
	U50	390	400	125	-2~-4	4.4
	U60	400	410	125	-2~-4	4.4
	U70	410	420	125	-2~-4	4.4

Notes:

1. The peak wavelength is measured with an accuracy of $\pm 1\text{nm}$
2. Minimum and maximum value refers to the limits and set up of SemiLEDs' testers. All other measurement data are defined as long-term production mean values and are only given for reference.
3. A critical component is a component used in a life-support device or system whose failure can reasonably be expected to cause the failure of that life-support device or system, or to affect its safety or effectiveness of that device or system. Life support devices or systems are intended (i) to be implanted in the human body, or (ii) to support and/or maintain and sustain human life. If they fail, it is reasonable to assume that the health of the user may be endangered. Components used as a critical component must be approved in writing by SemiLEDs.
4. These devices emit high intensity UV/NUV light. Necessary precautions must be taken during operation. Do not look directly into the light or look through the optical system when in operation. Protective eyewear should be worn at all times during operation.
5. Lens discoloration may occur with prolonged exposure to UV/NUV light. Lens material will need to be tested for UV/NUV light compatibility and durability.
6. Always follow thermal design recommendations in this document.

Caution: Users are requested to comply with the laws and public regulations concerning safety.

Radiometric Power and Forward Voltage (Tj=25°C)

Part number	Color	Performance at Test Current (350mA)				Performance at 700mA	
		Group	Minimum Radiometric Power (mW)	VF		Typical Radiometric Power (mW)	
				Min	Max		
N35L-U-A	U40 (380-390nm)	D1	200	3	4	385	
		D2	240	3	4	460	
		D3	280	3	4	540	
	U50 (390~400nm)	D4	320	3	4	615	
		D5	360	3	4	690	
		E1	400	3	4	770	
	U60 (400~410nm)	E2	440	3	4	845	
		D4	320	3	4	615	
		D5	360	3	4	690	
		E1	400	3	4	770	
		E2	440	3	4	845	
	U70 (410~420nm)	E3	480	3	4	925	
		D4	320	3	4	615	
		D5	360	3	4	690	
		E1	400	3	4	770	
		E2	440	3	4	845	
		E3	480	3	4	925	
			E4	520	3	4	1000

- Note: 1. Radiometric power is measured with an accuracy of ±10%
 2. The forward voltage is measured with an accuracy of ±0.1V
 * Calculated values are for reference only.

Forward Voltage Binning

Part number	Performance at Test Current (350mA)		
	Vf Group	Minimum (V)	Maximum (V)
N35L-U-A	V30	3.0	3.2
	V32	3.2	3.4
	V34	3.4	3.6
	V36	3.6	3.8
	V38	3.8	4.0

Relative Spectral Power Distribution, Ta=25 °C

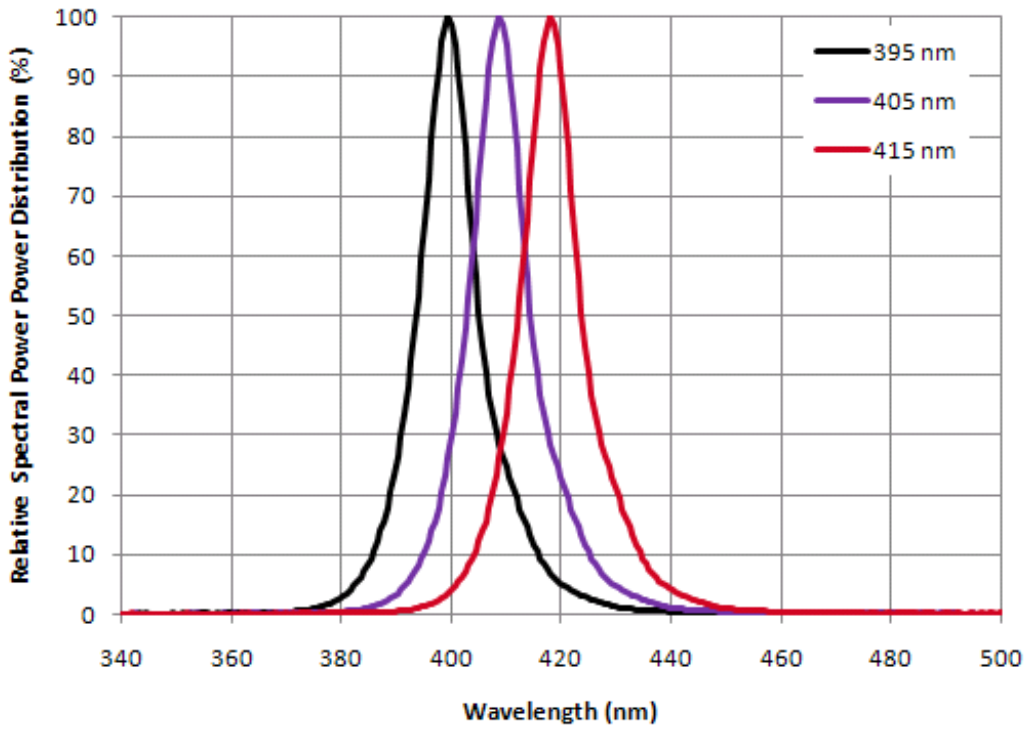

Typical Spatial Radiation Pattern

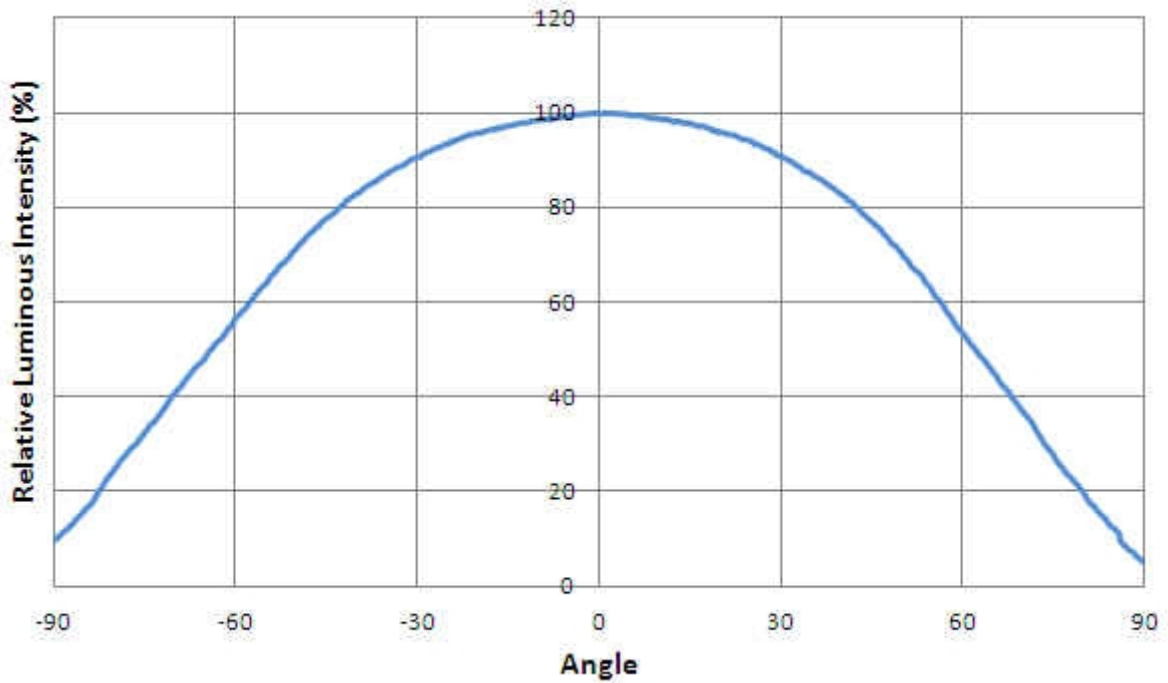

Thermal Design

Thermal design of the end product is important. The thermal resistance between the junction and the solder point ($R_{\theta_{j-p}}$) and the end product should be designed to minimize the thermal resistance from the solder point to ambient in order to optimize the emitter life and optical characteristics. The maximum operation current is determined by the plot of Allowable Forward Current vs. Ambient Temperature.

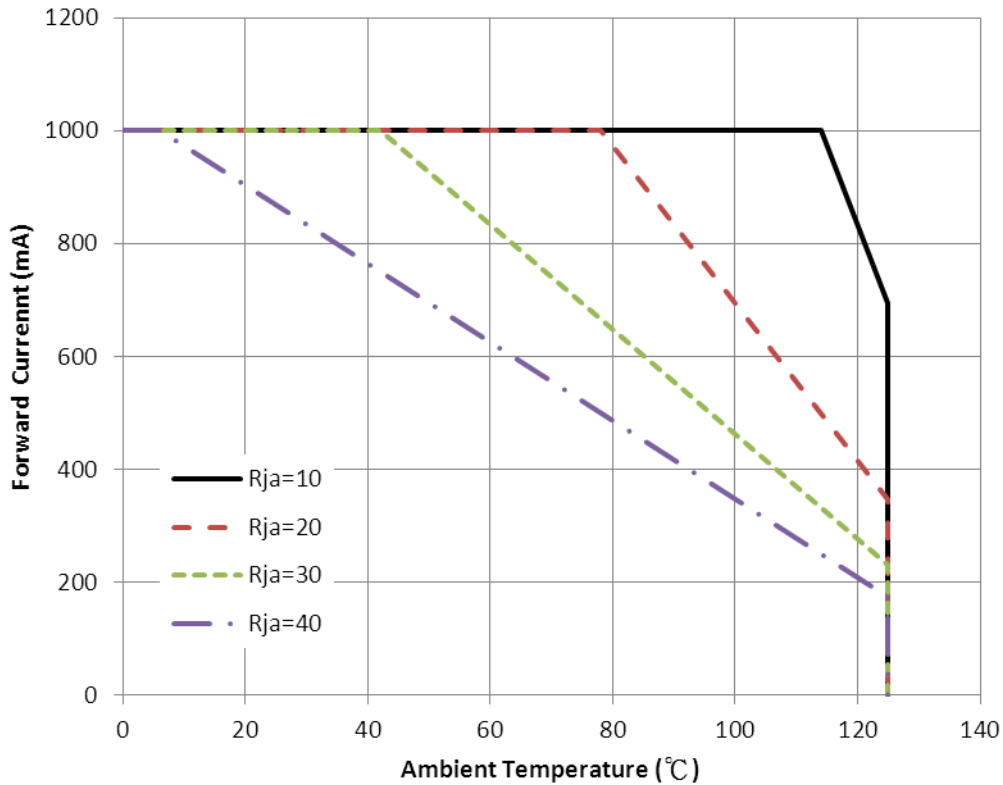

The junction temperature can be correlated to the thermal resistance between the junction and ambient (R_{ja}) by the following equation.

$$T_j = T_a + R_{ja} * W$$

T_j : LED junction temperature

T_a : Ambient temperature

R_{ja} : Thermal resistance between the junction and ambient

W : Input power ($I_F * V_F$)

Typical Forward L-I Characteristics

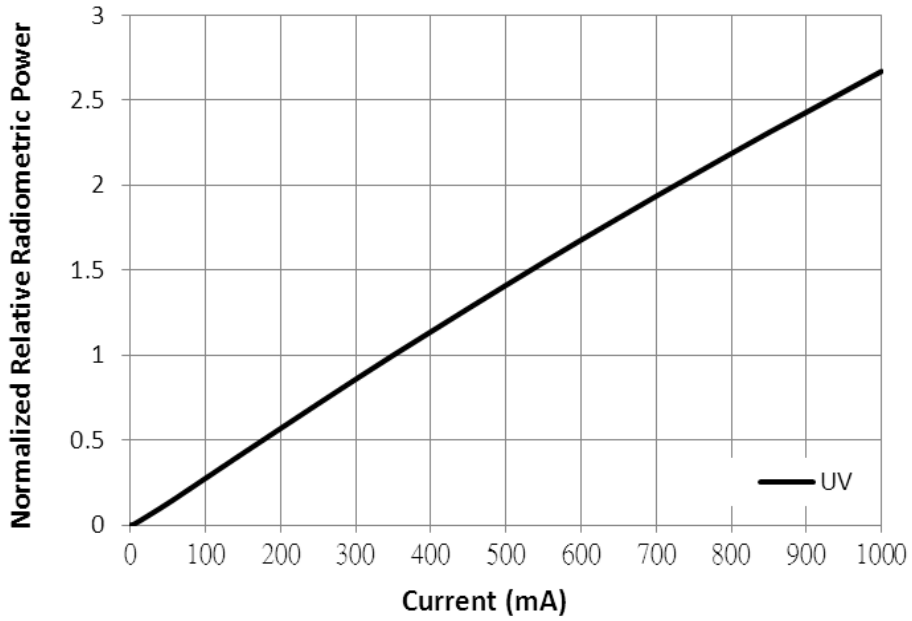

Typical Forward I-V Characteristics

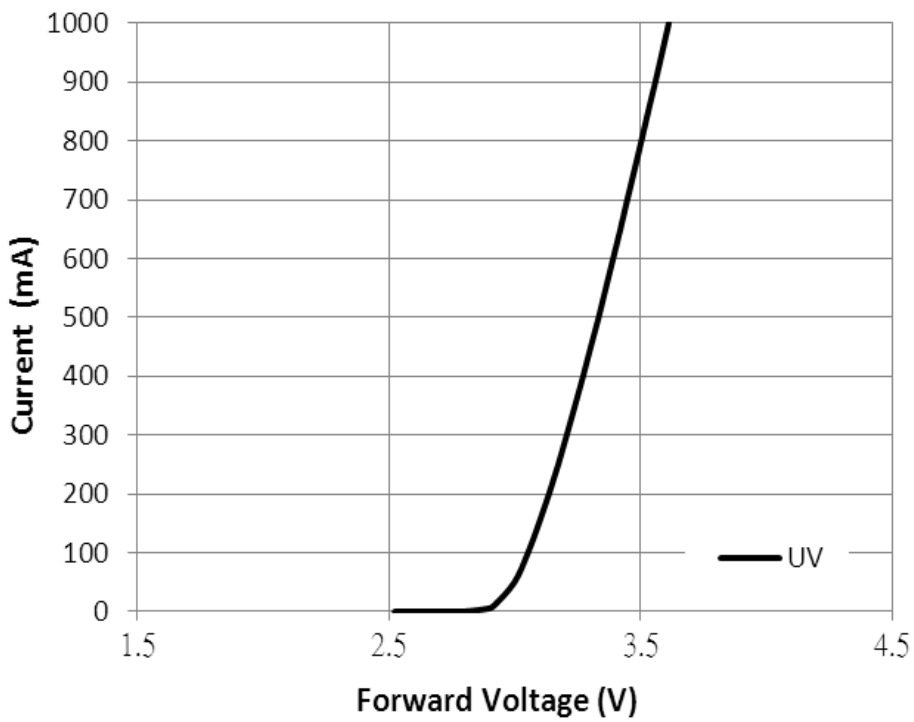

Typical Forward L-Tj Characteristics

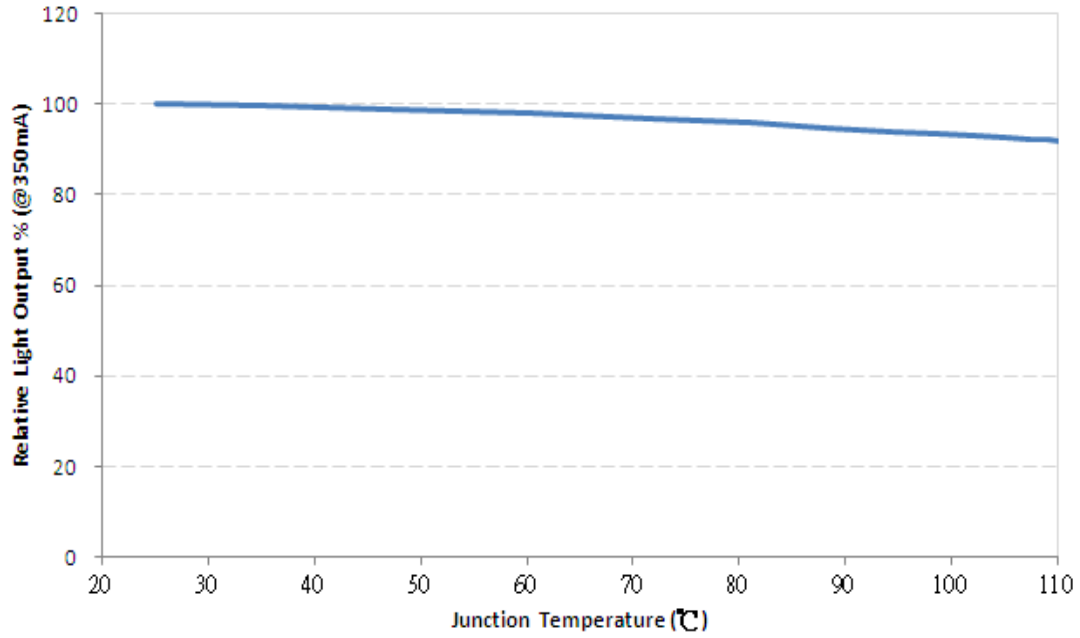

Mechanical Dimensions

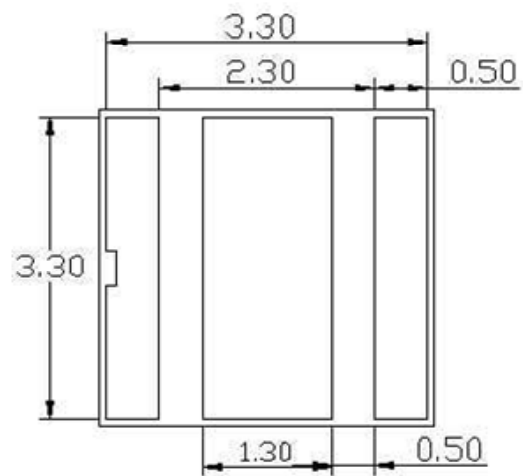
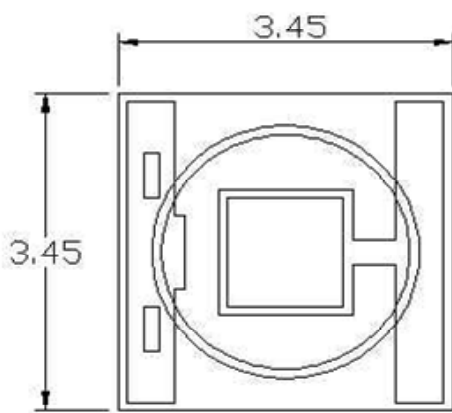
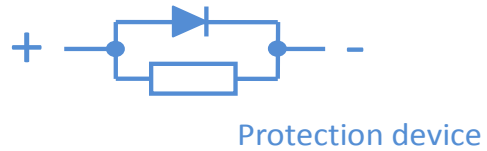
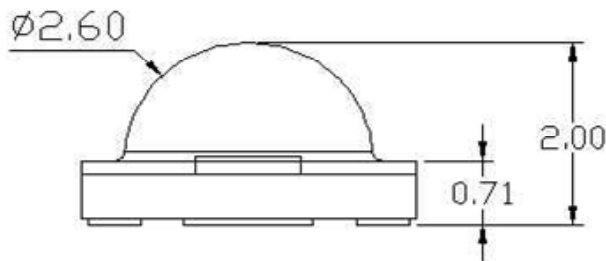
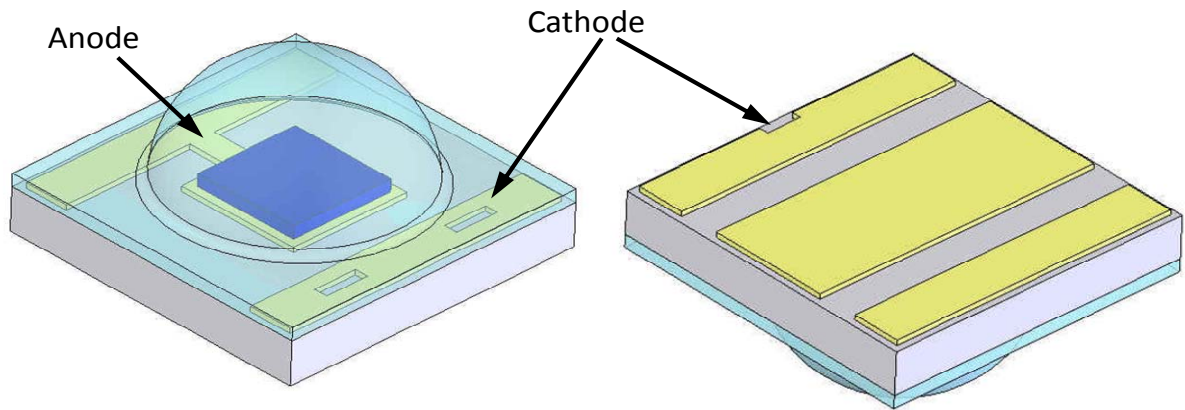

Notes :

1. Drawing is not to scale
2. All dimensions are in millimeter
3. Dimensions are $\pm 0.13\text{mm}$ unless otherwise indicated

Recommended Solder Pad Design

Recommended Soldering Pad Design

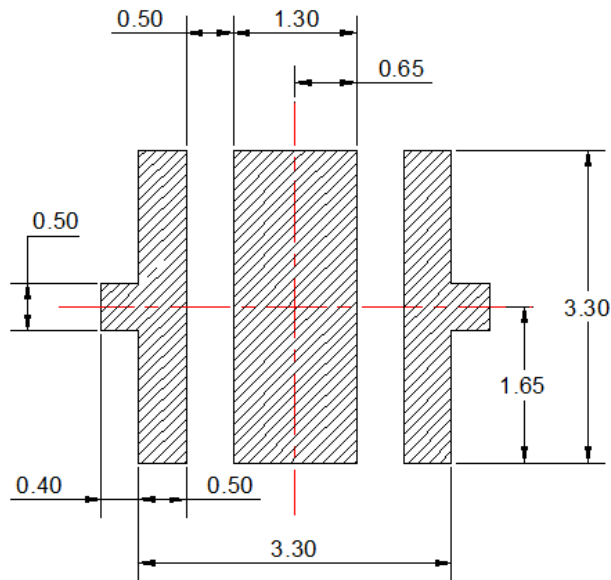

Recommended Stencil Pattern Design (Marked Area is Opening)

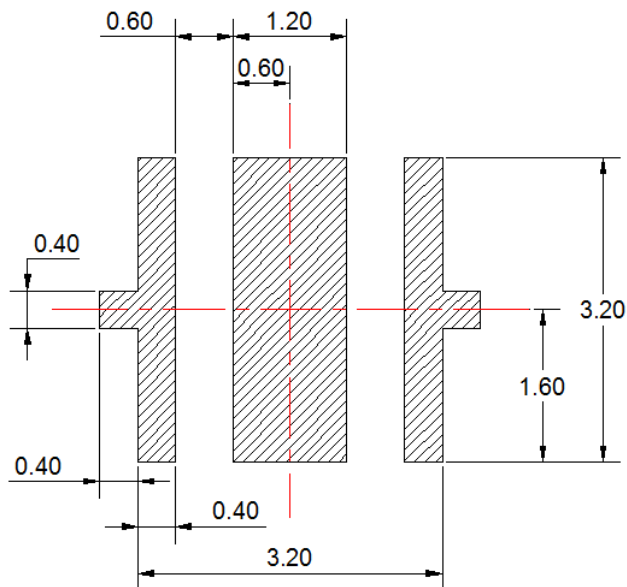

Notes :

1. Drawing is not to scale
2. All dimensions are in millimeter

Packing Information

The carrier tape conform to EIA-481D.

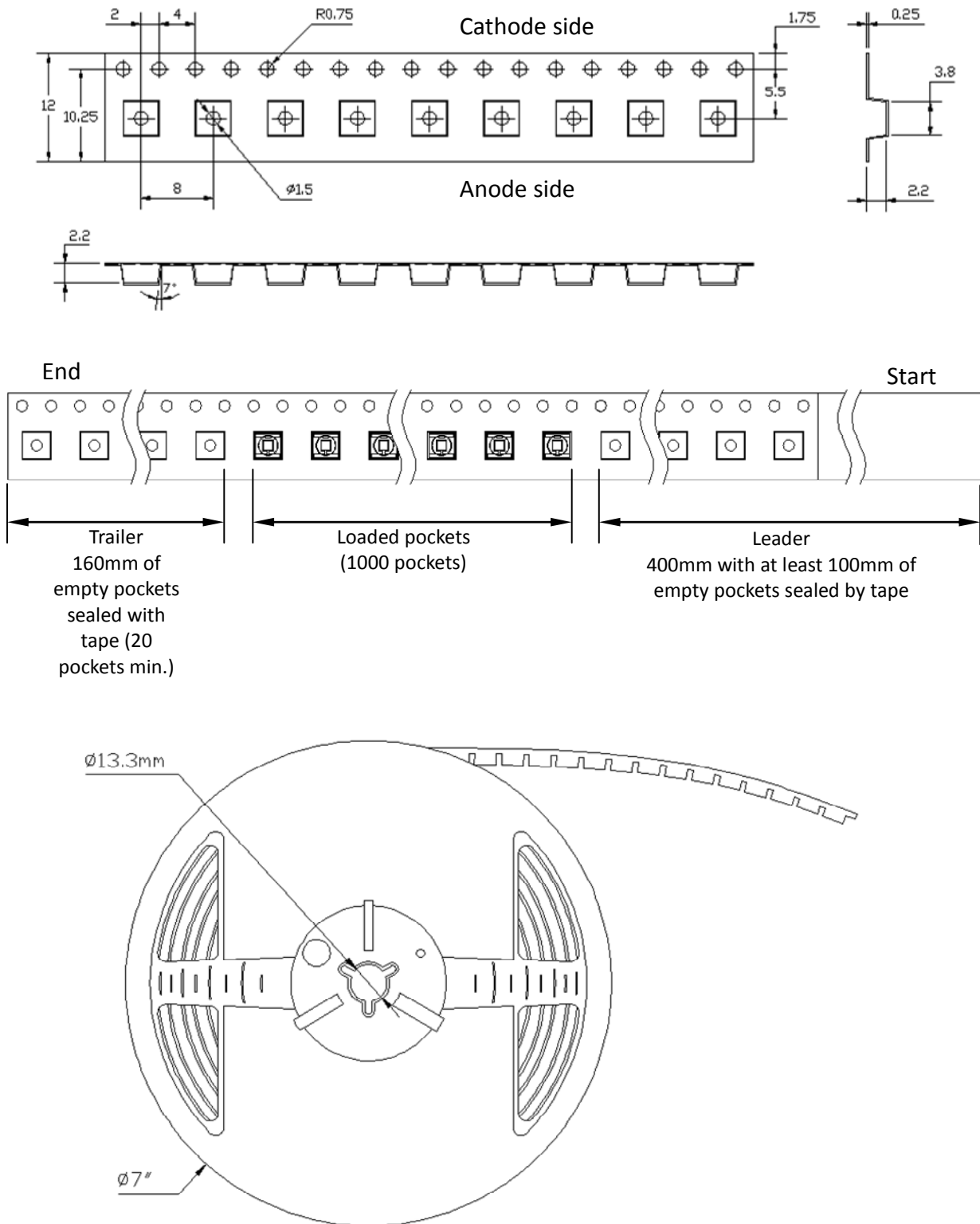

Note:

1. All dimensions are in millimeter.

Recommended Soldering Profile

The LEDs can be soldered using the parameters listed below. As a general guideline, the users are suggested to follow the recommended soldering profile provided by the manufacturer of the solder paste. Although the recommended soldering conditions are specified in the list, reflow soldering at the lowest possible temperature is advised for the LEDs.

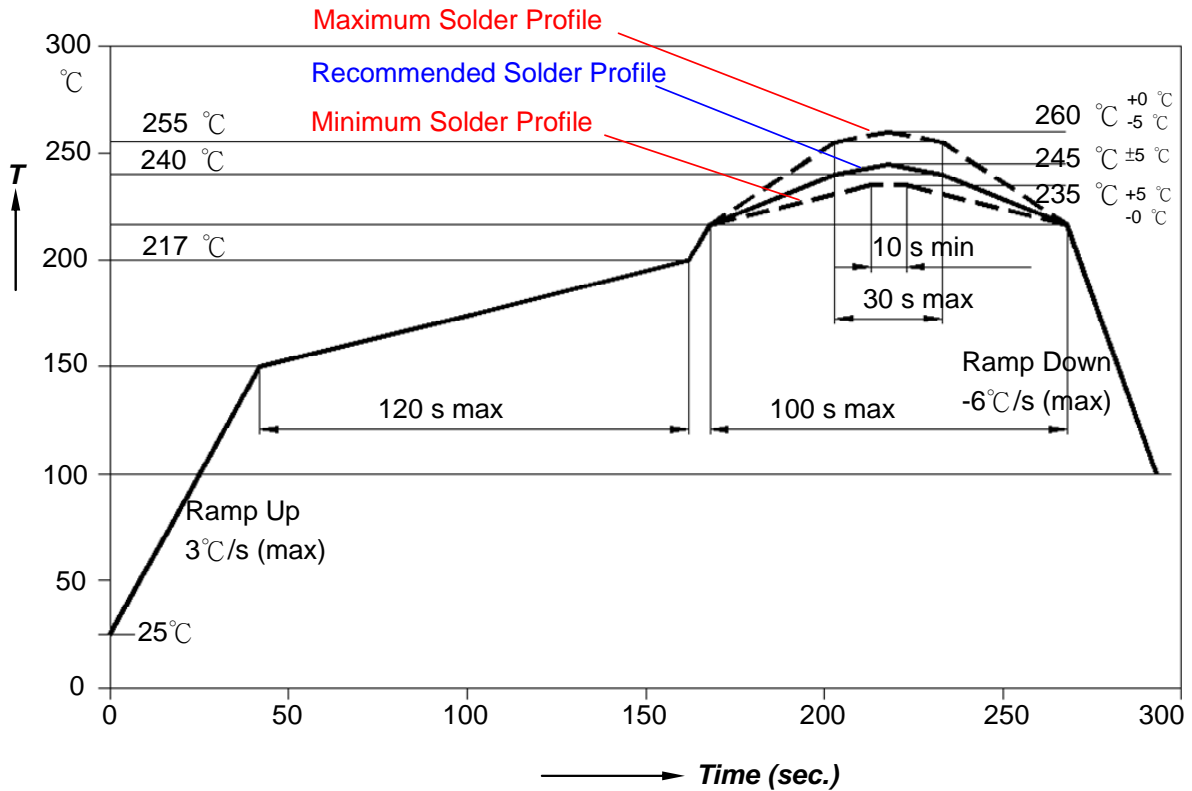

Profile Feature	Sn-Pb Eutectic Assembly	Pb-Free Assembly
Average Ramp-up Rate (T _{smax} to T _p)	3°C/second max.	3°C/second max.
Preheat		
- Temperature Min(T _{smin})	100°C	150°C
- Temperature Max(T _{smax})	150°C	200°C
- Time(ts _{min} to ts _{max})	60-120 seconds	60-180 seconds
Time maintained above:		
- Temperature(T _l)	183°C	217°C
- Time(t _l)	60-150 seconds	60-150 seconds
Peak/classification Temperature(T _p)	215°C	260°C
Time within 5°C of actual Peak Temperature(tp)	10-30 seconds	20-40 seconds
Ramp-Down Rate	6°C/second max.	6°C/second max.
Time 25°C to Peak Temperature	6 minutes max.	8 minutes max.

About Us

SemiLEDs Corporation is a US based manufacturer of ultra-high brightness LED chips with state of the art fabrication facilities in Hsinchu Science Park, Taiwan. SemiLEDs specializes in the development and manufacturing of vertical LED chips in blue (white), green, and UV using a patented copper alloy base. This unique design allows for higher performance and longer lumen maintenance. In December 2008, The World Economic Forum recognized SemiLEDs innovations with the 2009 Technology Pioneer Award. SemiLEDs is fully ISO 9001:2008 Certified

SemiLEDs is a publicly traded company on NASDAQ Global Select Market (stock symbol "LEDS"). For investor information, please contact us at investors@semileds.com.

For further company or product information, please visit us at www.semileds.com or please contact sales@semileds.com.



www.semileds.com

ASIA PACIFIC

3F, No. 11, KeJung Rd.

Chu-Nan Site

Hsinchu Science Park

Chu-Nan 350, Miao-Li County

Taiwan, ROC

Tel: +886-37-586788

Fax: +886-37-582688

sales@semileds.com